

ČSN 22 3010

NO

HSS

Set of hand taps Satzgewindebohrer Метчики наборные

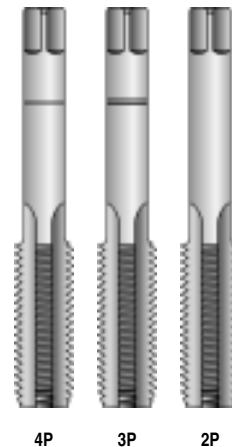
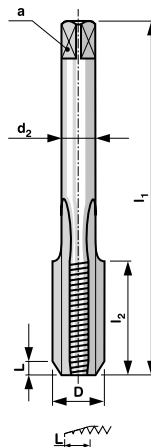
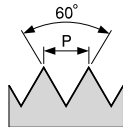
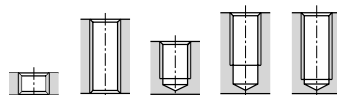

/ Tolerance: 2N /
Toleranz: 2N / Подгонка: 2N

M

Standard metric thread
Metrische Regelgewinde
Метрическая резьба

MF

Fine metric thread
Metrische Feingewinde
Мелкая метрическая резьба

D	P	l ₁	l ₂	d ₂	a		*	code NO/CS	code HSS
M 2	0,4	34	8	2,5	2	1,6	3	110 020	140 020
M 2,2	0,45	34	9	2,8	2,24	1,75	3	110 022	140 022
M 2,5	0,45	34	10	2,8	2,24	2,05	3	110 025	140 025
M 2,5	0,35	28	8	2,8	2,24	2,15	2	110 026	140 026
M 3	0,5	36	10	3,15	2,5	2,5	3	110 030	140 030
M 3	0,35	32	8	3,15	2,5	2,65	2	110 031	140 031
M 3,5	0,6	36	12	3,55	2,8	2,9	3	110 035	140 035
M 3,5	0,35	32	9	3,55	2,8	3,15	2	110 036	140 036
M 4	0,7	41	14	4	3,15	3,3	3	110 040	140 040
M 4	0,5	38	11	4	3,15	3,5	2	110 041	140 041
M 4,5	0,5	38	11	4,5	3,55	4,0	2	110 046	140 046
M 5	0,8	45	16	5	4	4,2	3	110 050	140 050
M 5	0,5	40	11	5	4	4,5	2	110 051	140 051
M 5,5	0,5	40	12	5,6	4,5	5,0	2	110 056	140 056
M 6	1	50	17	4,5	3,55	5,0	3	110 060	140 060
M 6	0,75	44	15	4,5	3,55	5,2	2	110 061	140 061
M 7	1	50	17	5,6	4,5	6,0	3	110 070	140 070
M 7	0,75	44	15	5,6	4,5	6,2	2	110 071	140 071
M 8	1,25	54	22	6	5	6,8	3	110 080	140 080
M 8	1	46	16	6	5	7,0	2	110 081	140 081
M 8	0,75	44	16	6	5	7,2	2	110 082	140 082
M 9	1,25	60	22	7,1	5,6	7,8	3	110 090	140 090
M 9	1	52	17	7,1	5,6	8,0	2	110 091	140 091
M 9	0,75	50	17	7,1	5,6	8,2	2	110 092	140 092
M 10	1,5	63	25	7,1	5,6	8,5	3	110 100	140 100
M 10	1,25	56	18	7,1	5,6	8,8	2	110 101	140 101
M 10	1	56	18	7,1	5,6	9,0	2	110 102	140 102
M 10	0,75	56	18	7,1	5,6	9,2	2	110 103	140 103
M 11	1,5	63	28	8	6,3	9,5	3	110 110	140 110
M 11	1	56	20	8	6,3	10,0	2	110 111	140 111
M 11	0,75	56	20	8	6,3	10,2	2	110 112	140 112
M 12	1,75	70	30	9	7,1	10,2	3	110 120	140 120
M 12	1,5	63	25	9	7,1	10,5	2	110 121	140 121
M 12	1,25	60	22	9	7,1	10,8	2	110 122	140 122
M 12	1	60	22	9	7,1	11,0	2	110 123	140 123
M 14	2	80	30	11	9	12,0	3	110 140	140 140
M 14	1,5	70	28	11	9	12,5	2	110 141	140 141
M 14	1,25	63	25	11	9	12,8	2	110 142	140 142
M 14	1	63	25	11	9	13,0	2	110 143	140 143
M 15	1	70	25	11	9	14,0	2	110 152	140 152
M 16	2	80	35	12,5	10	14,0	3	110 160	140 160
M 16	1,5	70	28	12,5	10	14,5	2	110 161	140 161
M 16	1	70	25	12,5	10	15,0	2	110 162	140 162
M 17	1	70	28	12,5	10	16,0	2	110 171	140 171
M 18	2,5	90	36	14	11,2	15,5	3	110 180	140 180
M 18	1,5	80	32	14	11,2	16,5	2	110 181	140 181
M 18	1	70	28	14	11,2	17,0	2	110 182	140 182
M 20	2,5	90	36	14	11,2	17,5	3	110 200	140 200
M 20	1,5	80	32	14	11,2	18,5	2	110 201	140 201
M 20	1	75	28	14	11,2	19,0	2	110 202	140 202
M 22	2,5	90	40	16	12,5	19,5	3	110 220	140 220
M 22	1,5	80	32	16	12,5	20,5	2	110 221	140 221
M 22	1	75	28	16	12,5	21,0	2	110 222	140 222
M 24	3	100	45	18	14	21,0	3	110 240	140 240
M 24	2	90	36	18	14	22,0	2	110 241	140 241
M 24	1,5	85	32	18	14	22,5	2	110 242	140 242
M 24	1	80	28	18	14	23,0	1	110 243	140 243
M 25	1,5	90	32	18	14	23,5	2	110 252	140 252
M 26	1,5	90	32	18	14	24,5	2	110 262	140 262
M 27	3	100	45	20	16	24	3	110 270	140 270



BUČOVICE TOOLS

Materiál: NO; HSS
Provedení: nebroušený závit
Závit: pravý,
levý - dle požadavku

Material: CS; HSS
Execution: non-ground thread
Thread: right-hand, left-hand
on request

Werkstoff: WS; HSS
Ausführung: nicht
geschliffenes Gewinde
Gewinde: rechts, links - nach
dem Anspruch

Материал: NO; HSS
Изготовлено:
нешлифованная резьба
Резьба: правая,
левая - по заказу

ČSN 22 3010

NO

HSS

Set of hand taps Satzgewindebohrer Метчики наборные

M

Standard metric thread
Metrische Regelgewinde
Метрическая резьба

MF

Fine metric thread
Metrische Feingewinde
Мелкая метрическая резьба

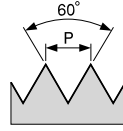
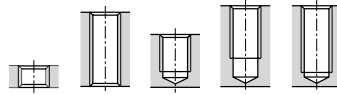

/ Tolerance: 2N /
Toleranz: 2N / Подгонка: 2N

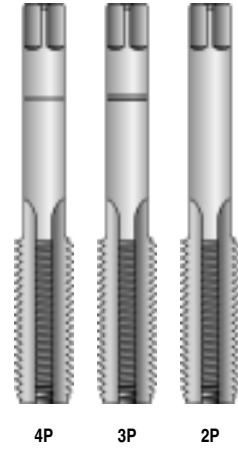
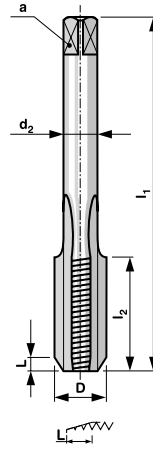

D	P	l ₁	l ₂	d ₂	a		*	code NO/CS	code HSS
M 27	2	90	36	20	16	25	2	110 271	140 271
M 27	1,5	90	32	20	16	25,5	2	110 272	140 272
M 27	1	85	28	20	16	26	1	110 273	140 273
M 28	2	100	36	20	16	26	2	110 281	140 281
M 28	1,5	90	32	20	16	26,5	2	110 282	140 282
M 30	3,5	120	50	20	16	26,5	3	110 300	140 300
M 30	2	100	36	20	16	28	2	110 301	140 301
M 30	1,5	100	32	20	16	28,5	2	110 302	140 302
M 30	1	85	32	20	16	29	1	110 303	140 303

* / pcs in set / Stck in Satz / штук в наборе

Material: NO: HSS
Provedení: nebroušený závit
Závit: pravý,
levý - dle požadavku

Material: CS: HSS
Execution: non-ground thread
Thread: right-hand, left-hand
on request

Werkstoff: WS: HSS
Ausführung: nicht
geschliffenes Gewinde
Gewinde: rechts, links - nach
dem Anspruch

Material: NO: HSS
Изготовлено:
нешлифованная резьба
Резьба: правая,
левая - по заказу

BUČOVICE TOOLS

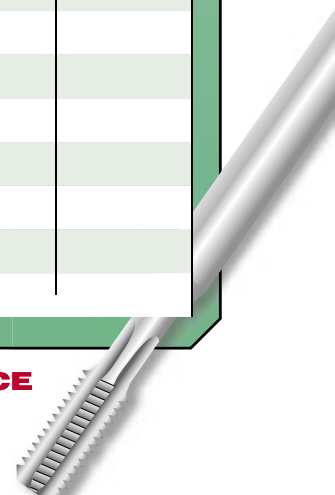

PN 8/3011**NO****HSS**

Set of hand taps
Satzgewindebohrer
Метчики наборные

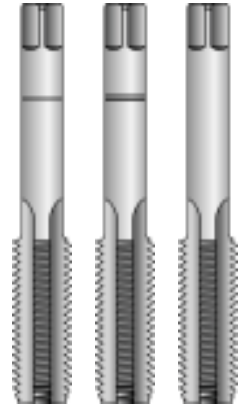
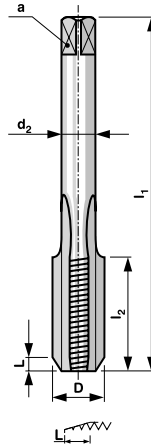
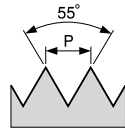
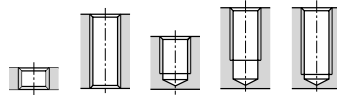

4P 3P 2P

W

Whitworth thread
 Whitworth-Gewinde
 Резьба Витворта

• / Tolerance: medium /
 Toleranz: mittel / Подгонка: средний класс

D	z/1"	P	l ₁	l ₂	d ₂	a		*	code NO/CS	code HSS
W 3/32"	48	0,529	34	10	3,15	2,5	1,75	3	111 332	141 332
W 1/8"	40	0,635	37	12	4	3,15	2,4	3	111 180	141 180
W 5/32"	32	0,794	41	14	5	4	3,0	3	111 532	141 532
W 3/16"	24	1,058	44	18	5	4	3,5	3	111 316	141 316
W 7/32"	24	1,058	44	18	5,6	4,5	4,3	3	111 732	141 732
W 1/4"	20	1,270	48	22	6,3	5	4,9	3	111 140	141 140
W 5/16"	18	1,411	51	26	5,6	4,5	6,4	3	111 516	141 516
W 3/8"	16	1,588	60	26	7,1	5,6	7,7	3	111 380	141 380
W 7/16"	14	1,814	60	28	8	6,3	9,1	3	111 716	141 716
W 1/2"	12	2,117	70	32	9	7,1	10,3	3	111 120	141 120
W 9/16"	12	2,117	70	32	9	7,1	11,8	3	111 916	141 916
W 5/8"	11	2,309	80	36	12,5	10	13,25	3	111 580	141 580
W 3/4"	10	2,540	90	40	14	11,2	16,25	3	111 340	141 340
W 7/8"	9	2,822	100	45	18	14	19	3	111 780	141 780
W 1"	8	3,175	110	45	20	16	21,75	3	111 100	141 100

* / pcs in set / Stck in Satz / штук в наборе



BUČOVICE TOOLS

Materiál: NO; HSS
 Provedení: nebroušený závit

Material: CS; HSS
 Execution: non-ground thread

Werkstoff: WS; HSS
 Ausführung: nicht geschliffenes Gewinde

Материал: NO; HSS
 Изготовлено: нешлифованная резьба

ČSN 22 3012

NO

HSS

Set of hand taps Satzgewindebohrer Метчики наборные

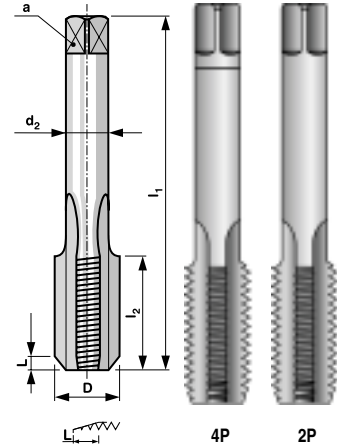
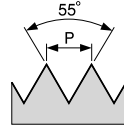
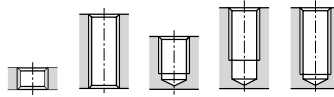

: A / Tolerance: A /
Toleranz: A / Подгонка: A

G

Pipe thread
Rohrgewinde
Трубная резьба

D	z/1"	P	l ₁	l ₂	d ₂	a		*	code NO/CS	code HSS
G 1/16"	28	0,907	52	14	5,6	4,5	6,7	2	112 116	142 116
G 1/8"	28	0,907	59	15	8	6,3	8,8	2	112 180	142 180
G 1/4"	19	1,337	67	19	10	8	11,7	2	112 140	142 140
G 3/8"	19	1,337	75	21	12,5	10	15,2	2	112 380	142 380
G 1/2"	14	1,814	87	26	16	12,5	18,8	2	112 120	142 120
G 5/8"	14	1,814	91	26	18	14	20,75	2	112 580	142 580
G 3/4"	14	1,814	96	28	20	16	24,25	2	112 340	142 340
G 7/8"	14	1,814	102	29	22,4	18	28	2	112 780	142 780
G 1"	11	2,309	109	33	25	20	30,5	2	112 100	142 100

Materiál: NO; HSS
Provedení: nebroušený závit

Material: CS; HSS
Execution: non-ground thread

Werkstoff: WS; HSS
Ausführung: nicht
geschliffenes Gewinde

Материал: NO; HSS
Изготовлено: нешлифо-
ванная резьба

PN 8/3014

NO

Set of hand taps Satzgewindebohrer Метчики наборные

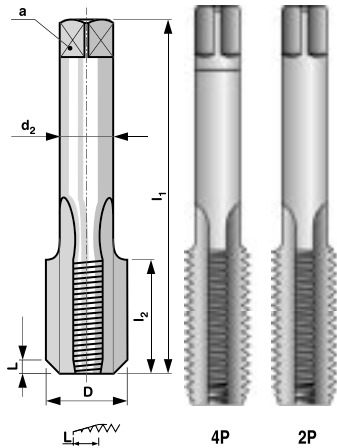
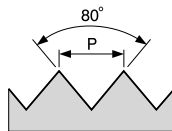
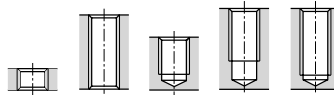

P

Steel conduit thread
Stahlpanzerrohr-Gewinde
Панцирная резьба

D	z/1"	P	l ₁	l ₂	d ₂	a		*	code NO/CS
P 7	20	1,270	63	28	9	7,1	11,3	2	113 070
P 9	18	1,411	70	28	10	8	13,8	2	113 090
P 11	18	1,411	80	32	12,5	10	17,2	2	113 110
P 13,5	18	1,411	80	32	16	12,5	19,0	2	113 135
P 16	18	1,411	85	32	18	14	21,0	2	113 160
P 21	16	1,588	90	36	20	16	26,75	2	113 210

Materiál: NO
Provedení: nebroušený závit

Material: CS
Execution: non-ground thread

Werkstoff: WS
Ausführung: nicht
geschliffenes Gewinde

Материал: NO
Изготовлено:
нешлифованная резьба

BUČOVICE TOOLS

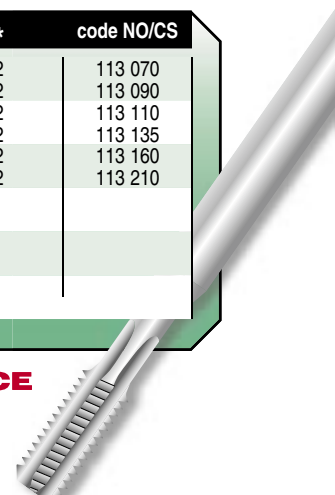

DIN 352**NO****HSS**

Set of hand taps
Satzgewindebohrer
Метчики наборные

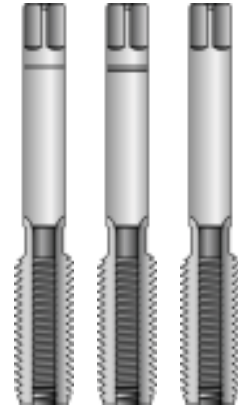
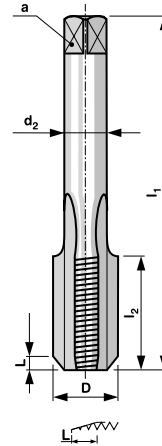
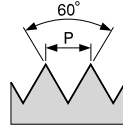
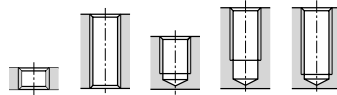

/ Tolerance: 2N /
 Toleranz: 2N / Подгонка: 2N

M

Standard metric thread
 Metrische Regelgewinde
 Метрическая резьба

D	P	l ₁	l ₂	d ₂	a		*	code NO/CS	code HSS
M 2	0,4	36	8	2,8	2,1	1,60	3	114 020	144 020
M 2,2	0,45	36	9	2,8	2,1	1,75	3	114 022	144 022
M 2,5	0,45	40	9	2,8	2,1	2,05	3	114 025	144 025
M 3	0,5	40	11	3,5	2,7	2,50	3	114 030	144 030
M 3,5	0,6	45	13	4	3	2,9	3	114 035	144 035
M 4	0,7	45	13	4,5	3,4	3,3	3	114 040	144 040
M 4,5	0,75	50	16	6	4,9	4,0	3	114 045	144 045
M 5	0,8	50	16	6	4,9	4,2	3	114 050	144 050
M 6	1	50	19	6	4,9	5,0	3	114 060	144 060
M 7	1	50	19	6	4,9	6,0	3	114 070	144 070
M 8	1,25	56	22	6	4,9	6,8	3	114 080	144 080
M 9	1,25	63	22	7	5,5	7,8	3	114 090	144 090
M 10	1,5	70	24	7	5,5	8,5	3	114 100	144 100
M 11	1,5	70	24	8	6,2	9,5	3	114 110	144 110
M 12	1,75	75	29	9	7	10,2	3	114 120	144 120
M 14	2	80	30	11	9	12,0	3	114 140	144 140
M 16	2	80	32	12	9	14,0	3	114 160	144 160
M 18	2,5	95	40	14	11	15,5	3	114 180	144 180
M 20	2,5	95	40	16	12	17,5	3	114 200	144 200
M 22	2,5	100	40	18	14,5	19,5	3	114 220	144 220
M 24	3	110	50	18	14,5	21,0	3	114 240	144 240
M 27	3	110	50	20	16	24	3	114 270	144 270
M 30	3,5	125	56	22	18	26,5	3	114 300	144 300

* / pcs in set / Stck in Satz / штук в наборе



BUČOVICE
TOOLS

Materiál: NO; HSS
 Provedení: nebroušený závit
 Závit: pravý

Material: CS; HSS
 Execution: non-ground thread
 Thread: right-hand

Werkstoff: WS; HSS
 Ausführung: nicht
 geschliffenes Gewinde
 Gewinde: rechts

Материал: NO; HSS
 Изготовлено:
 нешлифованная резьба
 Резьба: правая

DIN 2181**NO****HSS**

Set of hand taps
Satzgewindebohrer
Метчики наборные

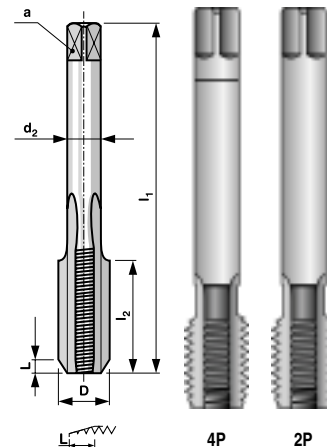
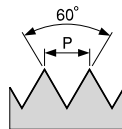
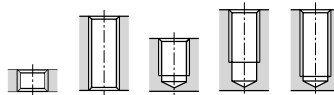

/ Tolerance: 2N /
 Toleranz: 2N / Подгонка: 2N

MF

Fine metric thread
 Metrische Feingewinde
 Мелкая метрическая резьба

D	P	l ₁	l ₂	d ₂	a		*	code NO/CS	code HSS
M 2,5	0,35	40	9	2,8	2,1	2,15	2	114 026	144 026
M 3	0,35	40	9	3,5	2,7	2,65	2	114 031	144 031
M 3,5	0,35	45	10	4,0	3,0	3,15	2	114 036	144 036
M 4	0,5	45	10	4,5	3,4	3,50	2	114 041	144 041
M 4,5	0,5	50	12	6,0	4,9	4,0	2	114 046	144 046
M 5	0,5	50	12	6,0	4,9	4,5	2	114 051	144 051
M 5,5	0,5	50	12	6,0	4,9	5,0	2	114 056	144 056
M 6	0,75	50	14	6,0	4,9	5,2	2	114 061	144 061
M 7	0,75	50	14	6,0	4,9	6,2	2	114 071	144 071
M 8	1	56	22	6,0	4,9	7,0	2	114 081	144 081
M 8	0,75	50	19	6,0	4,9	7,2	2	114 082	144 082
M 9	1	63	22	7,0	5,5	8,0	2	114 091	144 091
M 9	0,75	56	19	7,0	5,5	8,2	2	114 092	144 092
M 10	1,25	70	24	7,0	5,5	8,8	2	114 101	144 101
M 10	1	63	20	7,0	5,5	9,0	2	114 102	144 102
M 10	0,75	63	20	7,0	5,5	9,2	2	114 103	144 103
M 11	1	63	20	8,0	6,2	10,0	2	114 111	144 111
M 11	0,75	63	20	8,0	6,2	10,2	2	114 112	144 112
M 12	1,5	70	22	9,0	7,0	10,5	2	114 121	144 121
M 12	1,25	70	22	9,0	7,0	10,8	2	114 122	144 122
M 12	1	70	22	9,0	7,0	11,0	2	114 123	144 123
M 14	1,5	70	22	11	9,0	12,5	2	114 141	144 141
M 14	1,25	70	22	11	9,0	12,8	2	114 142	144 142
M 14	1	70	22	11	9,0	13,0	2	114 143	144 143
M 15	1	70	22	12	9,0	14,0	2	114 152	144 152
M 16	1,5	70	22	12	9,0	14,5	2	114 161	144 161
M 16	1	70	22	12	9,0	15,0	2	114 162	144 162
M 17	1	70	22	12	9,0	16,0	2	114 171	144 171
M 18	1,5	80	22	14	11,0	16,5	2	114 181	144 181
M 18	1	80	22	14	11,0	17,0	2	114 182	144 182
M 20	1,5	80	22	16	12,0	18,5	2	114 201	144 201
M 20	1	80	22	16	12,0	19,0	2	114 202	144 202
M 22	1,5	80	22	18	14,5	20,5	2	114 221	144 221
M 22	1	80	22	18	14,5	21,0	2	114 222	144 222
M 24	2	90	22	18	14,5	22,0	2	114 241	144 241
M 24	1,5	90	22	18	14,5	22,5	2	114 242	144 242
M 24	1	90	22	18	14,5	23,0	2	114 243	144 243
M 25	1,5	90	22	18	14,5	23,5	2	114 252	144 252
M 26	1,5	90	22	18	14,5	24,5	2	114 262	144 262
M 27	2	90	22	20	16	25	2	114 271	144 271
M 27	1,5	90	22	20	16	25,5	2	114 272	144 272
M 27	1	90	22	20	16	26	2	114 273	144 273
M 28	2	90	22	20	16	26	2	114 281	144 281
M 28	1,5	90	22	20	16	26,5	2	114 282	144 282
M 30	2	90	22	22	18	28	2	114 301	144 301
M 30	1,5	90	22	22	18	28,5	2	114 302	144 302
M 30	1	90	22	22	18	29	2	114 303	144 303

*

/ pcs in set / Stick in Satz / штук в наборе

Materiál: NO: HSS
 Provedení: nebroušený závit
 Závit: pravý

Material: CS: HSS
 Execution: non-ground thread
 Thread: right-hand

Werkstoff: WS: HSS
 Ausführung: nicht
 geschliffenes Gewinde
 Gewinde: rechts

Material: NO: HSS
 Изготовлено:
 нешлифованная резьба
 Резьба: правая

 **BUČOVICE**
TOOLS

DIN 352**NO****HSS**

Set of hand taps
Satzgewindebohrer
Метчики наборные

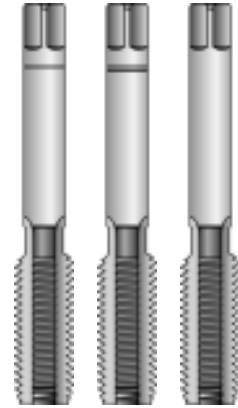
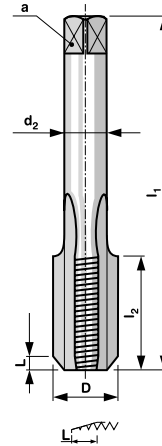
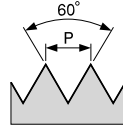
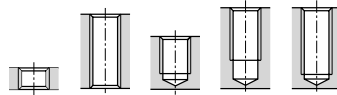

4P

3P

2P

: 2B / Tolerance: 2B /
 Toleranz: 2B / Подгонка: 2B

UNC

Unified coarse thread
 Unified-Grobgewinde
 Унифицированная чёрная резьба

D	z/1"	P	l ₁	l ₂	d ₂	a		*	code NO/CS	code HSS
4	40	0,635	40	11	3,5	2,7	2,2	3	125 004	145 004
5	40	0,635	40	11	3,5	2,7	2,6	3	125 005	145 005
6	32	0,794	45	12	4	3	2,85	3	125 006	145 006
8	32	0,794	45	13	4,5	3,4	3,5	3	125 008	145 008
10	24	1,058	50	16	6	4,9	3,9	3	125 010	145 010
12	24	1,058	50	16	6	4,9	4,5	3	125 012	145 012
1/4	20	1,270	50	19	6	4,9	5,2	3	125 140	145 140
5/16	18	1,411	53	22	6	4,9	6,6	3	125 516	145 516
3/8	16	1,588	70	24	7	5,5	8,0	3	125 380	145 380
7/16	14	1,814	70	24	8	6,2	9,4	3	125 716	145 716
1/2	13	1,954	75	28	9	7	10,75	3	125 120	145 120
9/16	12	2,117	80	30	11	9	12,25	3	125 916	145 916
5/8	11	2,309	80	32	12	9	13,5	3	125 580	145 580
3/4	10	2,540	95	34	14	11	16,5	3	125 340	145 340
7/8	9	2,822	100	34	18	14,5	19,5	3	125 780	145 780
1	8	3,175	110	38	18	14,5	22,25	3	125 100	145 100

* / pcs in set / Stk in Satz / штук в наборе



BUČOVICE
TOOLS

Materiál: NO; HSS
 Provedení: nebroušený závit

Material: CS; HSS
 Execution: non-ground thread

Werkstoff: WS; HSS
 Ausführung: nicht geschliffenes Gewinde

Материал: NO; HSS
 Изготовлено: нешлифованная резьба

DIN 2181

NO

HSS

Set of hand taps Satzgewindebohrer Метчики наборные

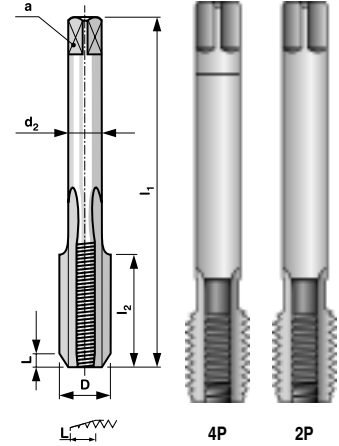
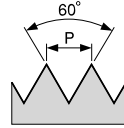
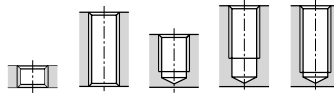

: 2B / Tolerance: 2B /
Toleranz: 2B / Подгонка: 2B

UNF

Unified fine thread
Unified-Feingewinde
Унифицированная мелкая резьба

D	z/1"	P	l ₁	l ₂	d ₂	a		*	code NO/CS	code HSS
4	48	0,529	40	9	3,5	2,7	2,3	2	126 004	146 004
5	44	0,577	40	9	3,5	2,7	2,7	2	126 005	146 005
6	40	0,635	45	10	4	3	3,0	2	126 006	146 006
8	36	0,706	45	10	4,5	3,4	3,5	2	126 008	146 008
10	32	0,794	50	12	6	4,9	4,1	2	126 010	146 010
12	28	0,907	50	12	6	4,9	4,65	2	126 012	146 012
1/4	28	0,907	50	14	6	4,9	5,5	2	126 140	146 140
5/16	24	1,058	56	22	6	4,9	6,9	2	126 516	146 516
3/8	24	1,058	63	20	7	5,5	8,5	2	126 380	146 380
7/16	20	1,270	63	20	8	6,2	9,9	2	126 716	146 716
1/2	20	1,270	70	22	9	7	11,5	2	126 120	146 120
9/16	18	1,411	70	22	11	9	12,9	2	126 916	146 916
5/8	18	1,411	70	22	12	9	14,5	2	126 580	146 580
3/4	16	1,588	80	22	14	11	17,5	2	126 340	146 340
7/8	14	1,814	80	22	18	14,5	20,5	2	126 780	146 780
1	12	2,117	80	22	18	14,5	23,25	2	126 100	146 100

* / pcs in set / Stk in Satz / штук в наборе

Materiál: NO: HSS
Provedení: nebroušený závit

Material: CS: HSS
Execution: non-ground thread

Werkstoff: WS: HSS
Ausführung: nicht geschliffenes Gewinde

Material: NO: HSS
Изготовлено: нешлифованная резьба

BUČOVICE TOOLS

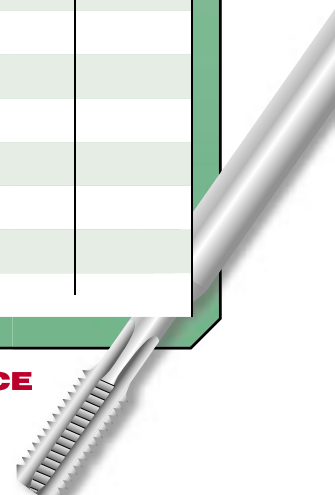

ČSN 22 3062

NO

Nut taps Muttergewindebohrer Метчики гаечные

M

Standard metric thread
Metrische Regelgewinde
Метрическая резьба

MF

Fine metric thread
Metrische Feingewinde
Мелкая метрическая резьба

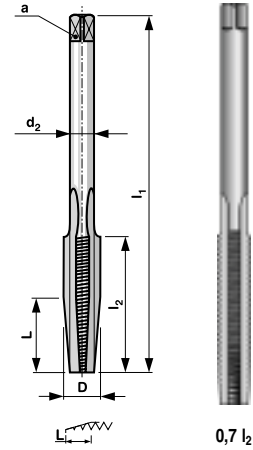
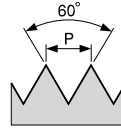

/ Tolerance: 2N /
Toleranz: 2N / Подгонка: 2N

0,7 l₂

D	P	l ₁	l ₂	d ₂		a	code NO/CS
M 5	0,8	70	28	3,55	4,2	2,8	117 050
M 5,5	0,5	63	24	4,0	5,0	3,15	117 055
M 6	1	80	32	4,7	5,0	3,55	117 060
M 7	1	80	32	5,6	6,0	4,5	117 070
M 8	1,25	90	38	6,3	6,8	5	117 080
M 8	1	80	32	6,3	7,0	5	117 081
M 9	1,25	100	38	7,1	7,8	5,6	117 090
M 10	1,5	110	45	7,1	8,5	5,6	117 100
M 10	0,75	90	30	7,1	9,2	5,6	117 103
M 12	1,75	125	50	9	10,2	7,1	117 120
M 14	2	140	60	11,2	12,0	9	117 140
M 16	2	140	60	12,5	14,0	10	117 160
M 18	2,5	160	70	14	15,5	11,2	117 180
M 20	2,5	160	70	14	17,5	11,2	117 200
M 22	2,5	180	70	16	19,5	12,5	117 220
M 24	3	180	85	18	21,0	14	117 240



BUČOVICE TOOLS

Materiál: NO
Provedení: nebroušený závit
Závit: pravý

Material: CS
Execution: non-ground thread
Thread: right-hand

Werkstoff: WS
Ausführung: nicht geschliffenes Gewinde
Gewinde: rechts

Material: NO
Изготовлено: нешлифованная резьба
Резьба: правая

PN 8/3070**NO****HSS**

Nut taps
Muttergewindebohrer
Метчики гаечные

M

Standard metric thread
 Metrische Regelgewinde
 Метрическая резьба

MF

Fine metric thread
 Metrische Feingewinde
 Мелкая метрическая резьба

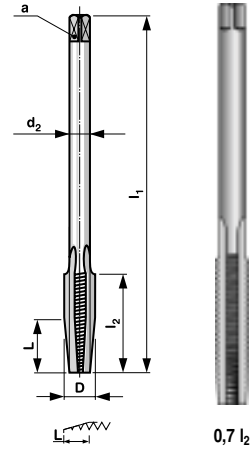
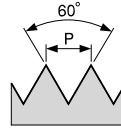

/ Tolerance: 2N /
 Toleranz: 2N / Подгонка: 2N

0,7 l₂

D	P	l ₁	l ₂	d ₂		a	code NO/CS	code NO/CS LH	code HSS
M 3	0,5	48	13	2,24	2,5	-	118 030	128 030	148 030
M 3,5	0,6	52	15	2,5	2,9	-	118 035	128 035	148 035
M 4	0,7	58	18	2,8	3,3	-	118 040	128 040	148 040
M 5	0,8	70	20	3,55	4,2	2,8	118 050	128 050	148 050
M 6	1	80	25	4,7	5,0	3,55	118 060	128 060	148 060
M 7	1	80	25	5,6	6,0	4,5	118 070	128 070	148 070
M 7	0,75	70	20	5,6	6,2	4,5	118 071		148 071
M 8	1,25	90	30	6,3	6,8	5	118 080	128 080	148 080
M 8	1	80	25	6,3	7,0	5	118 081		148 081
M 10	1,5	110	35	7,1	8,5	5,6	118 100	128 100	148 100
M 10	1,25	90	30	7,1	8,8	5,6	118 101		148 101
M 10	1	90	25	7,1	9,0	5,6	118 102		148 102
M 12	1,75	125	43	9	10,2	7,1	118 120	128 120	148 120
M 12	1,5	110	35	9	10,5	7,1	118 121		148 121
M 12	1,25	110	30	9	10,8	7,1	118 122		148 122
M 12	1	110	25	9	11,0	7,1	118 123		148 123
M 14	2	140	50	11,2	12,0	9	118 140		148 140
M 14	1,5	110	35	11,2	12,5	9	118 141		148 141
M 16	2	140	50	12,5	14,0	10	118 160		148 160
M 16	1,5	125	35	12,5	14,5	10	118 161		148 161
M 18	2,5	160	60	14	15,5	11,5	118 180		148 180
M 18	1,5	125	35	14	16,5	11,2	118 181		148 181
M 20	2,5	160	60	14	17,5	11,2	118 200		148 200
M 20	1,5	140	35	14	18,5	11,2	118 201		148 201

Materiál: NO; HSS
 Provedení: nebroušený závit
 Závit: pravý, levý - dle požadavku

Material: CS; HSS
 Execution: non-ground thread
 Thread: right-hand, left-hand - on request

Werkstoff: WS; HSS
 Ausführung: nicht geschliffenes Gewinde
 Gewinde: rechts, links - nach dem Anspruch

Материал: NO; HSS
 Изготовлено: нешлифованная резьба
 Резьба: правая, левая - по заказу

BUČOVICE TOOLS



ČSN 22 3074**NO****HSS**

Nut taps Muttergewindebohrer Метчики гаечные

M

Standard metric thread
Metrische Regelgewinde
Метрическая резьба

MF

Fine metric thread
Metrische Feingewinde
Мелкая метрическая резьба

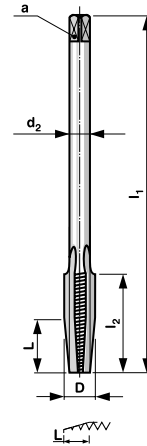
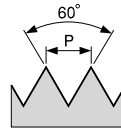

12 P

/ Tolerance: 2N /
Toleranz: 2N / Подгонка: 2N

D	P	l ₁	l ₂	d ₂		a	code NO/CS	code HSS
M 2	0,4	60	8	1,4	1,6	-	119 020	149 020
M 2,2	0,45	60	9	1,6	1,75	-	119 022	149 022
M 2,5	0,45	60	9	1,8	2,05	-	119 025	149 025
M 2,5	0,35	60	7	1,8	2,15	-	119 026	149 026
M 3	0,5	70	10	2,24	2,5	-	119 030	149 030
M 3	0,35	70	7	2,24	2,65	-	119 031	149 031
M 3,5	0,6	80	12	2,5	2,9	-	119 035	149 035
M 3,5	0,35	80	7	2,5	3,15	-	119 036	149 036
M 4	0,7	90	14	2,8	3,3	-	119 040	149 040
M 4	0,5	90	10	2,8	3,5	-	119 041	149 041
M 4,5	0,5	100	10	3,15	4,0	-	119 045	149 045
M 5	0,8	110	16	3,55	4,2	2,8	119 050	149 050
M 5	0,5	110	10	3,55	4,5	2,8	119 051	149 051
M 5,5	0,5	110	10	4,5	5,0	3,55	119 055	149 055
M 6	1	120	20	4,5	5,0	3,55	119 060	149 060
M 6	0,75	120	16	4,5	5,5	3,55	119 061	149 061
M 7	1	120	20	5,6	6,0	4,5	119 070	149 070
M 7	0,75	120	16	5,6	6,2	4,5	119 071	149 071
M 8	1,25	140	25	6,3	6,8	5	119 080	149 080
M 8	1	140	20	6,3	7,0	5	119 081	149 081
M 8	0,75	140	16	6,3	7,2	5	119 082	149 082
M 9	1	140	20	7,1	8,0	5,6	119 090	149 090
M 10	1,5	160	30	8	8,5	6,3	119 100	149 100
M 10	1,25	160	25	8	8,8	6,3	119 101	149 101
M 10	1	160	20	8	9,0	6,3	119 102	149 102
M 12	1,75	180	36	9	10,2	7,1	119 120	149 120
M 12	1,5	180	30	9	10,8	7,1	119 121	149 121
M 12	1,25	180	25	9	11,0	7,1	119 122	149 122
M 14	2	180	40	10	12,0	8	119 140	149 140
M 14	1,5	180	30	10	12,5	8	119 141	149 141
M 14	1,25	180	25	10	12,8	8	119 142	149 142
M 16	2	200	40	12,5	14,0	10	119 160	149 160
M 16	1,5	200	30	12,5	14,5	10	119 161	149 161
M 18	2,5	200	50	14	15,5	11,2	119 180	149 180
M 18	1,5	200	30	14	16,5	11,2	119 181	149 181
M 20	2,5	220	50	16	17,5	12,5	119 200	149 200
M 20	1,5	220	30	16	18,5	12,5	119 201	149 201
M 22	2,5	220	50	18	19,5	14	119 220	149 220
M 22	1,5	220	30	18	20,5	14	119 221	149 221
M 24	3	250	60	18	21,0	14	119 240	149 240
M 24	2	250	40	18	22,0	14	119 241	149 241
M 24	1,5	250	30	18	22,5	14	119 242	149 242



**BUČOVICE
TOOLS**

Materiál: NO; HSS
Provedení: nebroušený závit
Závit: pravý

Material: CS; HSS
Execution: non-ground thread
Thread: right-hand

Werkstoff: WS; HSS
Ausführung: nicht
geschliffenes Gewinde
Gewinde: rechts

Материал: NO; HSS
Изготовлено:
нешлифованная резьба
Резьба: правая

ČSN 22 3064**NO**

Nut taps Muttergewindebohrer Метчики гаечные

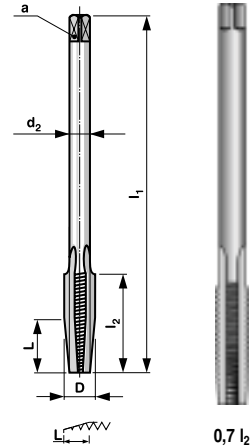
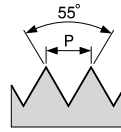
0,7 l₂**G**

Pipe thread
Rohrgewinde
Трубная резьба

/ Tolerance: 2N /
Toleranz: A / Подгонка: A

D	z/1"	P	l ₁	l ₂	d ₂	a		code NO/CS
G 1/16"	28	0,907	140	20	5,6	6,7	4,5	139 116
G 1/8"	28	0,907	140	20	8	8,8	6,3	139 180
G 1/4"	19	1,337	180	30	10	11,7	8	139 140
G 3/8"	19	1,337	200	30	12,5	15,2	10	139 380
G 1/2"	14	1,814	220	40	14	18,8	12,5	139 120
G 5/8"	14	1,814	220	40	18	20,75	14	139 580

Materiál: NO
Provedení: nebroušený závit
Závit: pravý

Material: CS
Execution: non-ground thread
Thread: right-hand

Werkstoff: WS
Ausführung: nicht
geschliffenes Gewinde
Gewinde: rechts

Материал: NO
Изготовлено:
нешлифованная резьба
Резьба: правая

PN 8/3016**HSS**

Screwdriver-bits Gewindebohrer-Bits Метчики с шестигран- ным держак

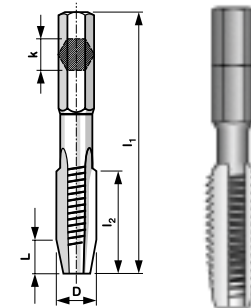
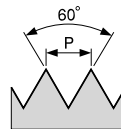

5P

M

Standard metric thread
Metrische Regelgewinde
Метрическая резьба

/ Tolerance: 2N /
Toleranz: 2N / Подгонка: 2N

D	P	l ₁	l ₂		k	code HSS
M 3	0,5	40	13	2,5	1/4"	940 030
M 4	0,7	40	12	3,3	1/4"	940 040
M 5	0,8	40	11,5	4,2	1/4"	940 050
M 6	1	40	11	5	1/4"	940 060
M 8	1,25	40	17	6,8	1/4"	940 080
M 10	1,5	40	15	8,5	1/4"	940 100
M 12	1,75	40	15	10,2	1/4"	940 120

Materiál: HSS
Provedení: nebroušený závit
Závit: pravý

Material: HSS
Execution: non-ground thread
Thread: right-hand

Werkstoff: HSS
Ausführung: nicht
geschliffenes Gewinde
Gewinde: rechts

Материал: HSS
Изготовлено:
нешлифованная резьба
Резьба: правая

**BUČOVICE
TOOLS**

PN 8/1371 (DIN 371)**HSS****HSSE****Machine taps**
with straight flute**Maschinen-Gewinde-
bohrer**

mit gerade Nuten

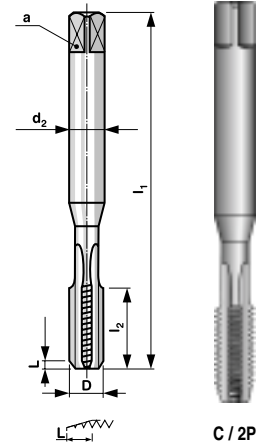
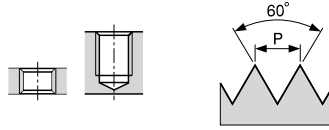
Механические метчики
с прямой канавкой

C / 2P

MStandard metric thread
Metrische Regelgewinde
Метрическая резьба/ Tolerance: 2N /
Toleranz: 2N / Подгонка: 2N

D	P	l ₁	l ₂	d ₂	a		code HSS	code HSSE
M 2	0,4	45	8	2,8	2,1	1,6	101 020	191 020
M 3	0,5	56	11	3,5	2,7	2,5	101 030	191 030
M 4	0,7	63	13	4,5	3,4	3,3	101 040	191 040
M 5	0,8	70	16	6,0	4,9	4,2	101 050	191 050
M 6	1	80	19	6,0	4,9	5	101 060	191 060
M 8	1,25	90	22	8,0	6,2	6,3	101 080	191 080
M 10	1,5	100	24	10,0	8,0	8,5	101 100	191 100

Materiál: HSS; HSSE
Provedení: nebroušený závit
Závit: pravýMaterial: HSS; HSSE
Execution: non-ground thread
Thread: right-handWerkstoff: HSS; HSSE
Ausführung: nicht
geschliffenes Gewinde
Gewinde: rechtsMaterial: HSS; HSSE
Изготовлено:
нешлифованная резьба
Резьба: правая**PN 8/1371** (DIN 371)**HSS****HSSE****Machine taps**
with spiral point**Maschinen-Gewinde-
bohrer**

mit Schälanschnitt

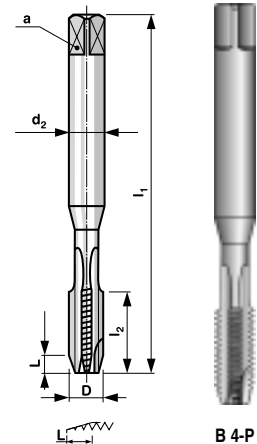
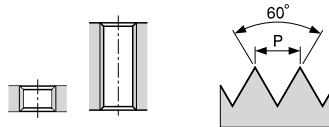
Механические метчики
с ломателем стружек

B 4-P

MStandard metric thread
Metrische Regelgewinde
Метрическая резьба/ Tolerance: 2N /
Toleranz: 2N / Подгонка: 2N

D	P	l ₁	l ₂	d ₂	a		code HSS	code HSSE
M 3	0,5	56	11	3,5	2,7	2,5	102 030	192 030
M 4	0,7	63	13	4,5	3,4	3,3	102 040	192 040
M 5	0,8	70	16	6,0	4,9	4,2	102 050	192 050
M 6	1	80	19	6,0	4,9	5	102 060	192 060
M 8	1,25	90	22	8,0	6,2	6,3	102 080	192 080
M 10	1,5	100	24	10,0	8,0	8,5	102 100	192 100

**BUČOVICE
TOOLS**Materiál: HSS; HSSE
Provedení: nebroušený závit
Závit: pravýMaterial: HSS; HSSE
Execution: non-ground thread
Thread: right-handWerkstoff: HSS; HSSE
Ausführung: nicht
geschliffenes Gewinde
Gewinde: rechtsMaterial: HSS; HSSE
Изготовлено:
нешлифованная резьба
Резьба: правая

PN 8/1371 (DIN 371)**HSS****HSSE**

35°

Machine taps
with spiral flute 35°**Maschinen-Gewinde-
bohrer**

mit Rechtsspiralnute 35°

Механические метчики

с винтовыми дорожками 35°

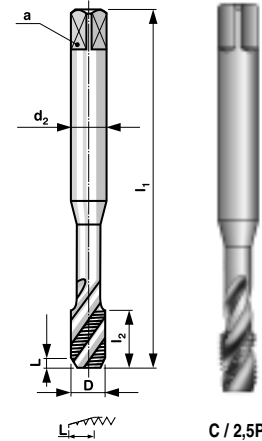
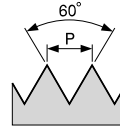
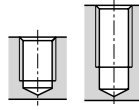
**M**Standard metric thread
Metrische Regelgewinde
Метрическая резьба/ Tolerance: 2N /
Toleranz: 2N / Подгонка: 2N

C / 2,5P

D	P	l ₁	l ₂	D	d ₂	a		code HSS	code HSSE
M 3	0,5	56	5	3,5	2,7	2,5		103 030	193 030
M 4	0,7	63	7	4,5	3,4	3,3		103 040	193 040
M 5	0,8	70	8	6,0	4,9	4,2		103 050	193 050
M 6	1	80	10	6,0	4,9	5		103 060	193 060
M 8	1,25	90	13	8,0	6,2	6,3		103 080	193 080
M 10	1,5	100	15	10,0	8,0	8,5		103 100	193 100

Materiál: HSS; HSSE
Provedení: nebroušený závit
Závit: pravýMaterial: HSS; HSSE
Execution: non-ground thread
Thread: right-handWerkstoff: HSS; HSSE
Ausführung: nicht
geschliffenes Gewinde
Gewinde: rechtsМатериал: HSS; HSSE
Изготовлено:
нешлифованная резьба
Резьба: правая**BUČOVICE
TOOLS**

PN 8/1374 (DIN 374)

HSS

Machine taps

with straight flute

**Maschinen-Gewinde-
bohrer**

mit gerade Nuten

Механические метчики

с прямой канавкой

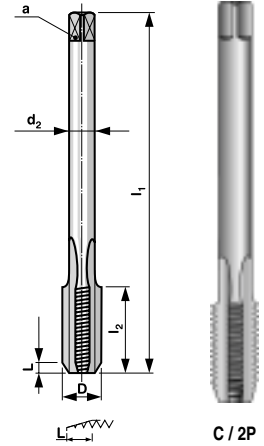
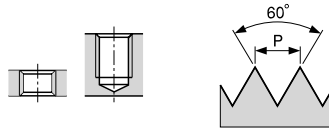

C / 2P

MF

Fine metric thread
Metrische Feingewinde
Мелкая метрическая резьба

/ Tolerance: 2N /
Toleranz: 2N / Подгонка: 2N

D	P	l ₁	l ₂	d ₂	a		code HSS
M 3	0,35	56	8	2,2	-	2,65	107 031
M 4	0,5	63	10	2,8	2,1	3,5	107 041
M 5	0,5	70	12	3,5	2,7	4,5	107 051
M 6	0,75	80	14	4,5	3,4	5,2	107 061
M 6	0,5	80	14	4,5	3,4	5,5	107 062
M 8	1	90	22	6,0	4,9	7,0	107 081
M 8	0,75	80	18	6,0	4,9	7,2	107 082
M 10	1,25	100	24	7,0	5,5	8,3	107 101
M 10	1	90	20	7,0	5,5	9,0	107 102
M 10	0,75	90	20	7,0	5,5	9,2	107 103
M 12	1,5	100	22	9,0	7,0	10,5	107 121
M 12	1,25	100	22	9,0	7,0	10,3	107 122
M 12	1	100	22	9,0	7,0	11,0	107 123
M 14	1,5	100	22	11,0	9,0	12,5	107 141
M 14	1,25	100	22	11,0	9,0	12,8	107 142
M 14	1	100	22	11,0	9,0	13,0	107 143
M 16	1,5	100	22	12,0	9,0	14,5	107 161
M 16	1	100	22	12,0	9,0	15,0	107 162
M 18	1,5	110	25	14,0	11,0	16,5	107 181
M 18	1	110	25	14,0	11,0	17,0	107 182
M 20	1,5	125	25	16,0	12,0	18,5	107 201
M 20	1	125	25	16,0	12,0	19,0	107 202
M 22	1,5	125	25	18,0	14,5	20,5	107 221
M 22	1	125	25	18,0	14,5	21,0	107 222
M 24	2	140	28	18,0	14,5	22,0	107 241
M 24	1,5	140	28	18,0	14,5	22,5	107 242
M 24	1	140	28	18,0	14,5	23,0	107 243
M 25	1,5	140	28	18,0	14,5	23,5	107 251
M 26	1,5	140	28	18,0	14,5	24,5	107 261
M 27	2	140	28	20,0	16,0	25,0	107 271
M 27	1,5	140	28	20,0	16,0	25,5	107 272
M 27	1	140	28	20,0	16,0	26,0	107 273
M 28	1,5	140	28	20,0	16,0	26,5	107 281
M 30	2	150	28	22,0	18,0	28,0	107 301
M 30	1,5	150	28	22,0	18,0	28,5	107 302
M 30	1	150	28	22,0	18,0	29,0	107 303



**BUČOVICE
TOOLS**

Materiál: HSS
Provedení: nebroušený závit
Závit: pravý

Material: HSS
Execution: non-ground thread
Thread: right-hand

Werkstoff: HSS
Ausführung: nicht
geschliffenes Gewinde
Gewinde: rechts

Материал: HSS
Изготовлено:
нешлифованная резьба
Резьба: правая

PN 8/1374 (DIN 374)**HSS****Machine taps**

with spiral point

**Maschinen-Gewinde-
bohrer**

mit Schälanschnitt

Механические метчики

с ломателем стружек

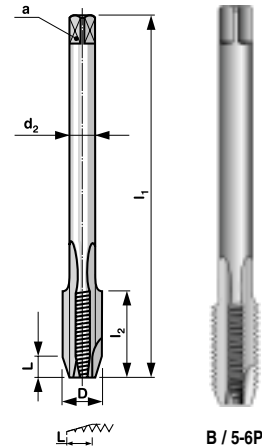
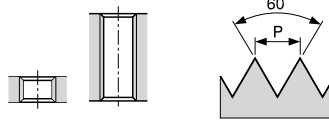

B / 5-6P

MF

Fine metric thread
Metrische Feingewinde
Мелкая метрическая резьба

/ Tolerance: 2N /
Toleranz: 2N / Подгонка: 2N

D	P	l ₁	l ₂	d ₂	a		code HSS
M 3	0,35	56	8	2,2	-	2,65	108 031
M 4	0,5	63	10	2,8	2,1	3,5	108 041
M 5	0,5	70	12	3,5	2,7	4,5	108 051
M 6	0,75	80	14	4,5	3,4	5,2	108 061
M 6	0,5	80	14	4,5	3,4	5,5	108 062
M 8	1	90	22	6,0	4,9	7,0	108 081
M 8	0,75	80	18	6,0	4,9	7,2	108 082
M 10	1,25	100	24	7,0	5,5	8,3	108 101
M 10	1	90	20	7,0	5,5	9,0	108 102
M 10	0,75	90	20	7,0	5,5	9,2	108 103
M 12	1,5	100	22	9,0	7,0	10,5	108 121
M 12	1,25	100	22	9,0	7,0	10,3	108 122
M 12	1	100	22	9,0	7,0	11,0	108 123
M 14	1,5	100	22	11,0	9,0	12,5	108 141
M 14	1,25	100	22	11,0	9,0	12,8	108 142
M 14	1	100	22	11,0	9,0	13,0	108 143
M 16	1,5	100	22	12,0	9,0	14,5	108 161
M 16	1	100	22	12,0	9,0	15,0	108 162
M 18	1,5	110	25	14,0	11,0	16,5	108 181
M 18	1	110	25	14,0	11,0	17,0	108 182
M 20	1,5	125	25	16,0	12,0	18,5	108 201
M 20	1	125	25	16,0	12,0	19,0	108 202

Materiál: HSS
Provedení: nebroušený závit
Závit: pravý

Material: HSS
Execution: non-ground thread
Thread: right-hand

Werkstoff: HSS
Ausführung: nicht
geschliffenes Gewinde
Gewinde: rechts

Материал: HSS
Изготовлено:
нешлифованная резьба
Резьба: правая

**BUČOVICE
TOOLS**

PN 8/1374 (DIN 374)**HSS**

35°

Machine taps

with spiral flute 35°

**Maschinen-Gewinde-
bohrer**

mit Rechtsspiralnute 35°

Механические метчики

с винтовыми дорожками 35°

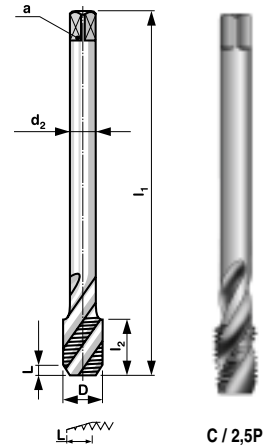
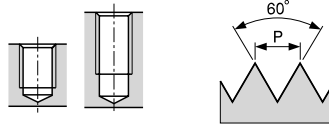
/ Tolerance: 2N /
Toleranz: 2N / Подгонка: 2N

C / 2,5P

MFFine metric thread
Metrische Feingewinde
Мелкая метрическая резьба

D	P	l ₁	l ₂	d ₂	a		code HSS
M 3	0,35	56	8	2,2	-	2,65	109 031
M 4	0,5	63	10	2,8	2,1	3,5	109 041
M 5	0,5	70	12	3,5	2,7	4,5	109 051
M 6	0,75	80	14	4,5	3,4	5,2	109 061
M 6	0,5	80	14	4,5	3,4	5,5	109 062
M 8	1	90	22	6,0	4,9	7,0	109 081
M 8	0,75	80	18	6,0	4,9	7,2	109 082
M 10	1,25	100	24	7,0	5,5	8,3	109 101
M 10	1	90	20	7,0	5,5	9,0	109 102
M 10	0,75	90	20	7,0	5,5	9,2	109 103
M 12	1,5	100	22	9,0	7,0	10,5	109 121
M 12	1,25	100	22	9,0	7,0	10,3	109 122
M 12	1	100	22	9,0	7,0	11,0	109 123
M 14	1,5	100	22	11,0	9,0	12,5	109 141
M 14	1,25	100	22	11,0	9,0	12,8	109 142
M 14	1	100	22	11,0	9,0	13,0	109 143
M 16	1,5	100	22	12,0	9,0	14,5	109 161
M 16	1	100	22	12,0	9,0	15,0	109 162
M 18	1,5	110	25	14,0	11,0	16,5	109 181
M 18	1	110	25	14,0	11,0	17,0	109 182
M 20	1,5	125	25	16,0	12,0	18,5	109 201
M 20	1	125	25	16,0	12,0	19,0	109 202
M 22	1,5	125	25	18,0	14,5	20,5	109 221
M 22	1	125	25	18,0	14,5	21,0	109 222
M 24	2	140	28	18,0	14,5	22,0	109 241
M 24	1,5	140	28	18,0	14,5	22,5	109 242
M 24	1	140	28	18,0	14,5	23,0	109 243
M 25	1,5	140	28	18,0	14,5	23,5	109 251
M 26	1,5	140	28	18,0	14,5	24,5	109 261
M 27	2	140	28	20,0	16,0	25,0	109 271
M 27	1,5	140	28	20,0	16,0	25,5	109 272
M 27	1	140	28	20,0	16,0	26,0	109 273
M 28	1,5	140	28	20,0	16,0	26,5	109 281
M 30	2	150	28	22,0	18,0	28,0	109 301
M 30	1,5	150	28	22,0	18,0	28,5	109 302
M 30	1	150	28	22,0	18,0	29,0	109 303

**BUČOVICE
TOOLS**Materiál: HSS
Provedení: nebroušený závit
Závit: pravýMaterial: HSS
Execution: non-ground thread
Thread: right-handWerkstoff: HSS
Ausführung: nicht
geschliffenes Gewinde
Gewinde: rechtsМатериал: HSS
Изготовлено:
нешлифованная резьба
Резьба: правая

PN 8/1376 (DIN 376)**HSS****HSSE****Machine taps**

with straight flute

Maschinen-Gewinde-bohrer

mit gerade Nuten

Механические метчики

с прямой канавкой

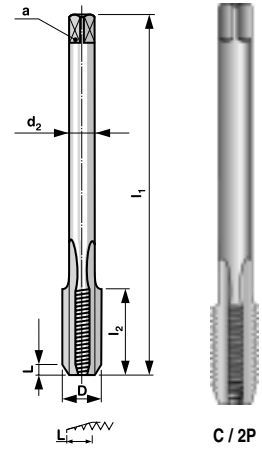
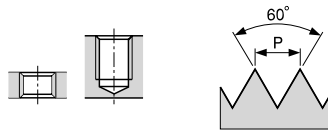
**M**Standard metric thread
Metrische Regelgewinde
Метрическая резьба/ Tolerance: 2N /
Toleranz: 2N / Подгонка: 2N

C / 2P

D	P	l ₁	l ₂	D	d ₂	a		code HSS	code HSSE
M 3	0,5	56	11		2,2	-	2,5	104 030	194 030
M 4	0,7	63	13		2,8	2,1	3,3	104 040	194 040
M 5	0,8	70	16		3,5	2,7	4,2	104 050	194 050
M 6	1	80	19		4,5	3,4	5,0	104 060	194 060
M 8	1,25	90	22		6,0	4,9	6,8	104 080	194 080
M 10	1,5	100	24		7,0	5,5	8,5	104 100	194 100
M 12	1,75	110	28		9,0	7,0	10,2	104 120	194 120
M 14	2	110	30		11,0	9,0	12,0	104 140	194 140
M 16	2	110	32		12,0	9,0	14,0	104 160	194 160
M 18	2,5	125	34		14,0	11,0	15,5	104 180	194 180
M 20	2,5	140	34		16,0	12,0	17,5	104 200	194 200
M 22	2,5	140	34		18,0	14,5	19,5	104 220	194 220
M 24	3	160	38		18,0	14,5	21,0	104 240	194 240
M 27	3	160	38		20,0	16,0	24,0	104 270	194 270
M 30	3,5	180	45		22,0	18,0	26,5	104 300	194 300

Materiál: HSS; HSSE
Provedení: nebroušený závit
Závit: pravýMaterial: HSS; HSSE
Execution: non-ground thread
Thread: right-handWerkstoff: HSS; HSSE
Ausführung: nicht
geschliffenes Gewinde
Gewinde: rechtsМатериал: HSS; HSSE
Изготовлено:
нешлифованная резьба
Резьба: правая

**BUČOVICE
TOOLS**

PN 8/1376 (DIN 376)

HSS

HSSE

Machine taps
with spiral point
**Maschinen-Gewinde-
bohrer**
mit Schälanschnitt
Механические метчики
с ломателем стружек

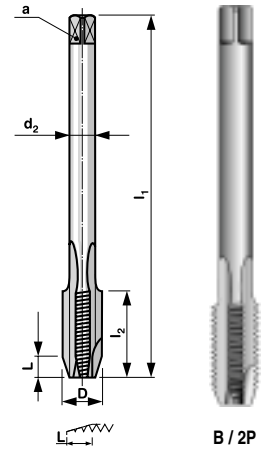
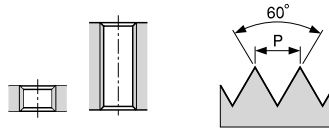

M Standard metric thread
Metrische Regelgewinde
Метрическая резьба

/ Tolerance: 2N /
Toleranz: 2N / Подгонка: 2N

B / 2P

D	P	l_1	l_2	d_2	a		code HSS	code HSSE
M 3	0,5	56	11	2,2	-	2,5	105 030	195 030
M 4	0,7	63	13	2,8	2,1	3,3	105 040	195 040
M 5	0,8	70	16	3,5	2,7	4,2	105 050	195 050
M 6	1	80	19	4,5	3,4	5,0	105 060	195 060
M 8	1,25	90	22	6,0	4,9	6,8	105 080	195 080
M 10	1,5	100	24	7,0	5,5	8,5	105 100	195 100
M 12	1,75	110	28	9,0	7,0	10,2	105 120	195 120
M 14	2	110	30	11,0	9,0	12,0	105 140	195 140
M 16	2	110	32	12,0	9,0	14,0	105 160	195 160
M 18	2,5	125	34	14,0	11,0	15,5	105 180	195 180
M 20	2,5	140	34	16,0	12,0	17,5	105 200	195 200



BUČOVICE TOOLS

Materiál: HSS; HSSE
Provedení: nebroušený závit
Závit: pravý

Material: HSS; HSSE
Execution: non-ground thread
Thread: right-hand

Werkstoff: HSS; HSSE
Ausführung: nicht geschliffenes Gewinde
Gewinde: rechts

Материал: HSS; HSSE
Изготовлено: нешлифованная резьба
Резьба: правая

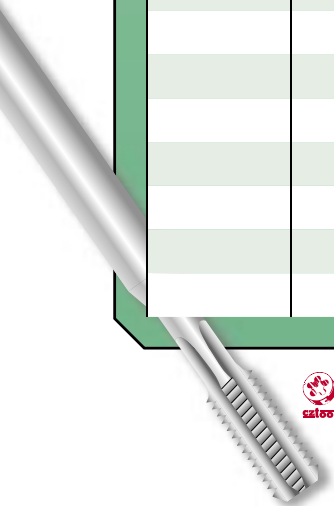

PN 8/1376 (DIN 376)

HSS

HSSE

35°

Machine taps

with spiral flute 35°

**Maschinen-Gewinde-
bohrer**

mit Rechtsspiralnute 35°

Механические метчики

с винтовыми дорожками 35°

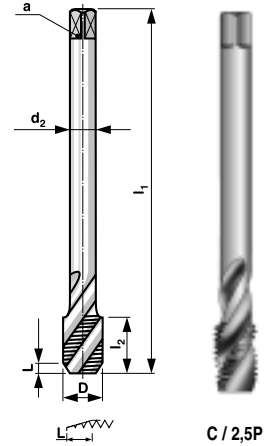
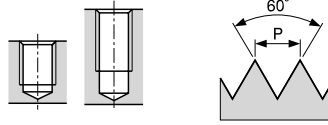

















M

Standard metric thread
Metrische Regelgewinde
Метрическая резьба

/ Tolerance: 2N /
Toleranz: 2N / Подгонка: 2N

C / 2,5P

D	P	l ₁	l ₂	D	d ₂	a		code HSS	code HSSE
M 3	0,5	56	5	2,2	-	2,5		106 030	196 030
M 4	0,7	63	7	2,8	2,1	3,3		106 040	196 040
M 5	0,8	70	8	3,5	2,7	4,2		106 050	196 050
M 6	1	80	10	4,5	3,4	5,0		106 060	196 060
M 8	1,25	90	13	6,0	4,9	6,8		106 080	196 080
M 10	1,5	100	15	7,0	5,5	8,5		106 100	196 100
M 12	1,75	110	18	9,0	7,0	10,2		106 120	196 120
M 14	2	110	20	11,0	9,0	12,0		106 140	196 140
M 16	2	110	20	12,0	9,0	14,0		106 160	196 160
M 18	2,5	125	25	14,0	11,0	15,5		106 180	196 180
M 20	2,5	140	25	16,0	12,0	17,5		106 200	196 200
M 22	2,5	140	25	18,0	14,5	19,5		106 220	196 220
M 24	3	160	30	18,0	14,5	21,0		106 240	196 240
M 27	3	160	30	20,0	16,0	24,0		106 270	196 270
M 30	3,5	180	35	22,0	18,0	26,5		106 300	196 300

Materiál: HSS; HSSE
Provedení: nebroušený závit
Závit: pravý

Material: HSS; HSSE
Execution: non-ground thread
Thread: right-hand

Werkstoff: HSS; HSSE
Ausführung: nicht
geschliffenes Gewinde
Gewinde: rechts

Материал: HSS; HSSE
Изготовлено:
нешлифованная резьба
Резьба: правая

 **BUČOVICE
TOOLS**



ČSN 22 3042**HSSE****Machine taps**
with straight flute**Maschinen-Gewinde-
bohrer**

mit gerade Nuten

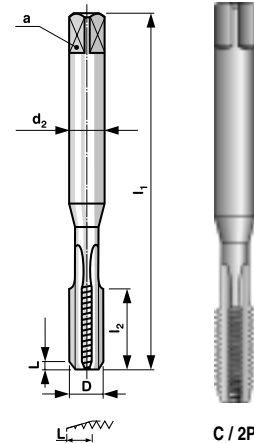
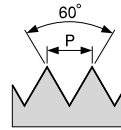
Механические метчики
с прямой канавкой**M**Standard metric thread
Metrische Regelgewinde
Метрическая резьба/ Tolerance: 2N /
Toleranz: ISO1 / Подгонка: ISO1

C / 2P

D	P	l ₁	l ₂	d ₂	a		code HSSE
M 3	0,5	48	11	3,15	2,5	2,5	162 030
M 4	0,7	53	13	4,0	3,15	3,3	162 040
M 5	0,8	58	16	5,0	4,0	4,2	162 050
M 6	1	66	19	6,3	5,0	5,0	162 060
M 8	1,25	72	22	8,0	6,3	6,8	162 080
M 10	1,5	80	24	10,0	8,0	8,5	162 100
M 12	1,75	89	29	9,0	7,1	10,2	162 120
M 14	2	95	30	11,2	9,0	12,0	162 140
M 16	2	102	32	12,5	10,0	14,0	162 160
M 18	2,5	112	37	14,0	11,2	15,5	162 180
M 20	2,5	112	37	14,0	11,2	17,5	162 200

Materiál: HSSE
Provedení: broušený závit
Závit: pravýMaterial: HSSE
Execution: ground thread
Thread: right-handWerkstoff: HSSE
Ausführung: geschliffenes
Gewinde
Gewinde: rechtsMaterial: HSSE
Изготовлено: шлифованная
резьба
Резьба: правая**ČSN 22 3043****HSSE****Machine taps**
with spiral point**Maschinen-Gewinde-
bohrer**

mit Schälanschnitt

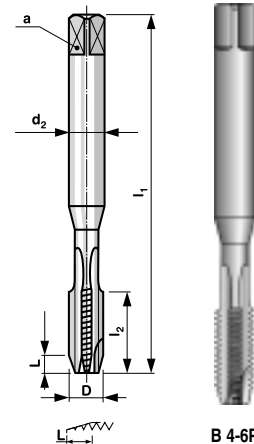
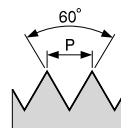
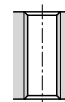
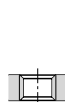
Механические метчики
с ломателем стружек**M**Standard metric thread
Metrische Regelgewinde
Метрическая резьба

Toleranz: ISO1 / Подгонка: ISO1

B 4-6P

D	P	l ₁	l ₂	d ₂	a		code HSSE
M 3	0,5	48	11	3,15	2,5	2,5	163 030
M 4	0,7	53	13	4,0	3,15	3,3	163 040
M 5	0,8	58	16	5,0	4,0	4,2	163 050
M 6	1	66	19	6,3	5,0	5,0	163 060
M 8	1,25	72	22	8,0	6,3	6,8	163 080
M 10	1,5	80	24	10,0	8,0	8,5	163 100
M 12	1,75	89	29	9,0	7,1	10,2	163 120
M 14	2	95	30	11,2	9,0	12,0	163 140
M 16	2	102	32	12,5	10,0	14,0	163 160
M 18	2,5	112	37	14,0	11,2	15,5	163 180
M 20	2,5	112	37	14,0	11,2	17,5	163 200

**BUČOVICE
TOOLS**Materiál: HSSE
Provedení: broušený závit
Závit: pravýMaterial: HSSE
Execution: ground thread
Thread: right-handWerkstoff: HSSE
Ausführung: geschliffenes
Gewinde
Gewinde: rechtsMaterial: HSSE
Изготовлено: шлифованная
резьба
Резьба: правая